

the Geode the Geode

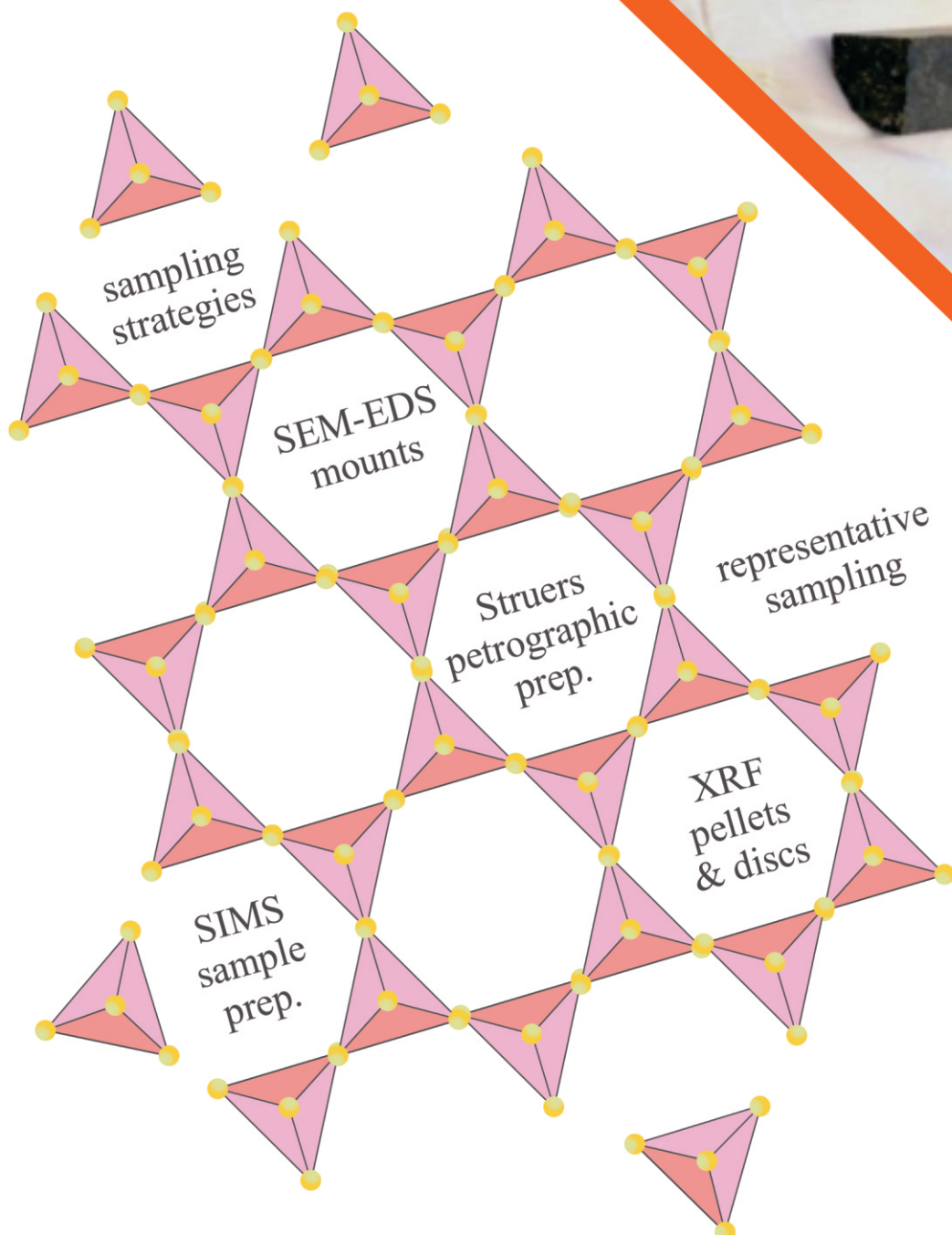

Samples, sampling,
and sample
preparation



The GEODE

Minsa
Newsletter
Volume 7
No. 3
December
2020



website: www.gssa.org.za/Minsa
e-mail: Minsa@gssa.org.za

the Geode the Geode

NEWSLETTER

Volume 7 No. 3

December 2020

“the magazine you can share, virus-free”

Contents:

- Message from the Chair
- Editor's Site
- Forthcoming Events
- **Issue theme: Samples, sampling, and sample preparation**
 - Robust sampling strategy: *Peter Rosewarne*
 - Representative sampling: *Maggi Loubser*
 - XRF pellets & discs: *David Long*
 - Struers petrographic preparation
 - Epoxy mounted particulates for SEM-EDS: *Igor Tonžetić*
 - SIMS sample prep: *Sarah Glynn & Michael Wiedenbeck*
 - Contrarian concepts: *Igor Tonžetić*
 - Micro-mineral collecting: *Graham Reeks*
- Other Gems
 - Minsa online symposium & student testimonials
 - Russian Bear Hug: Louis Cabri reminisces.
 - Bruce's Beauties: Argentine Rhodochrosite
- September crossword, & June solutions
- *Next issue theme:*

Mineralogical Pedagogics

From the Chair

Perhaps it is not particularly sensitive of myself to comment on the state of Minsa excursions in a time of lockdowns and curfews (I prefer the original French “curfue” meaning to cover fire – which “fire” being actually smothered in our current state of affairs being a matter for debate). But in previous years it has been suggested that Minsa has fewer excursions (and certainly less spectacular ones – a number of ones abroad come to mind) now than previously, because for instance the companies and corporations that geologists are working for are no longer willing to fund the attendance of such excursions or give paid leave. We also live in “busier” times with deadlines dictating our lives almost more than death itself (maybe we should rename deadlines “deadlives”). However, I don't necessarily think that this is so. A cursory look at a list of previous Minsa Chairs reveals that the most active years of Minsa were when chairs held their portfolios for multiple and extended periods of time. For instance take a look at the regimes of Sybrand de Waal (8 years Chair!) and the interleaved years of Sabine Verryn and Desh Chetty (3 years each spanning co-regency of over 6 years and a hugely successful IMA conference in 2014). These regimes were separated by about 20 years...and both were active. I would argue that this suggests that consistency in a leadership approach rather than a contemporary zeitgeist may have a greater effect on industriousness and activity

than has been previously appreciated. And I think I see this consistency slowly being replicated in the executive committees of the past few years. At least I hope so. The committees have remained largely unchanged...and I hope that this is a sign that Minsa membership is happy with the current status quo. At any rate, the committee has at least 3 excursions on our crosshairs for the next year. And I hope to prove that in my third year as chair we can attain some sense of our former glory. I certainly have the right team to back me up.



Igor Željko
Tonžetić

The Editor's Site

This issue of the Geode incorporates another new value-adding feature, namely this one, where the Editor gets to share his two cents-worth, with emphasis on the contents of the current issue. In this issue, our feature section on sample preparation includes thoughtful contributions on sampling philosophy and strategies, discussions of a wide range of aspects of sample preparation for XRF, SEM and SIMS, from the fundamental to the refined, and why they matter. To finish off, there is an introduction to and overview of the world of mineral microcollecting. The contributions are steeped with insights from extensive experience, in most cases. From my research perspective, I would also be interested to hear from labs who are deriving trace element data using LA-ICP-MS analysis on fused glass discs created for XRF, and/or stacks of pressed pellets, mounted and polished. There are cunning "shortcuts" along these lines that are providing research-quality data from approaches that are traditionally unconventional, and we would benefit from some exposure to them.



The Editor: "Look, I'm in the field".

In addition, this issue features a contribution kindly provided by Louis Cabri, who presented the pre-AGM Minsa talk in September entitled "Reflections on mineralogy over the past seven decades"; the short story which features here was one of many "but that's another story" moments from his very enjoyable, and quite inspiring, talk. To wrap up, Bruce Cairncross has provided his usual high quality photo-shoot, this time on rhodochrosite, specifically that deriving from Argentina, a regular feature which has now been expanded to two pages to maximise the impact of these photos and specimens. Use them as screen savers, or print 'em out and post them on your walls. Get Bruce to autograph them! (They last longer than autographs on body parts, and Bruce doesn't always carry a soft-tipped pen...). Rhodochrosite, which was first described from what is now Romania about 200 years ago, is named for the Greek term for "rose coloured", and has nothing to do with Rhodes, you may or may not be pleased to hear. As always, the issue concludes with a crossword, for those who haven't had enough mineralogical minutiae by then.

That's the perspective from the Editor's site.

Steve Prevec

Forthcoming Events & Attractions

- Excursion to tile factory – proposed for February 2021.
- Joint Minsa-SAMS excursion to the Rooiberg tin mines, suggested for March 2021.
- Phalaborwa visit – proposed for the end of winter or spring 2021.
- 5th Annual Southern African Mineral Symposium – Saturday 20 November 2021.
- Annual theme talk 2021: 'International Year of Creative Economy for Sustainable Development' – December 2021.

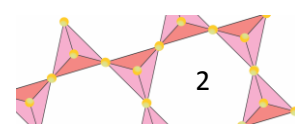



**FOR ALL YOUR
MINERALOGICAL
SPECIMEN PREPARATION
AND ANALYSIS NEEDS**



Thin Sectioning

- cutting, mounting, grinding/lapping and polishing



Light and X-Ray Microscopy

- brightfield, fluorescence, polarisation, diascopic and episcopic illumination
- 3D non-destructive tomography



Raman Microscopy

- confocal raman imaging, truesurface topography



Electron Microscopy

- imaging, identification, classification and analysis



(011)462-1363 | info@advancedlab.co.za | www.advancedlab.co.za

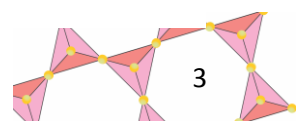

The September Geode Theme:

Samples, Sampling and Sample Preparation

Headlines:

- The Importance of a Robust Sampling Strategy.
- Representative Sampling – Why and How. A look at the need and the available resources.
- Some considerations for use of fusion discs and pressed pellets in routine XRF analysis.
- Thoughts on the potting and sizing of particulates mounted in 30 mm epoxy resin impregnated sample blocks typically used for Auto-SEM-EDS analysis.
- Secondary Ion Mass Spectrometry (SIMS) sample preparation: key guidelines for preparing good quality samples.
- Controversial contrarian concepts to consider when you're in a sample preparation bind.
- The world of the micro-collector.

The Importance of a Robust Sampling Strategy

Peter Rosewarne

Groundwater Consultant

Introduction

The following short article is based on the author's 45 years of experience as a hydrogeologist, mainly in southern Africa, including some related to shale gas, mining, nuclear sites, landfills, fuel and chemicals sites. Most of the projects had environmental impact assessments (EIAs) carried out and so the information contained therein is in the public domain. Sampling of soils and groundwater was a key component of most of these projects, although the general points raised below could apply equally to any sampling programme. This article is qualitative in nature and does not contain specific sampling results but rather looks at the principles behind a sound and successful sampling programme.

Discussion

The importance of a scientifically-based, credible, robust and legally defensible sampling process and data base in environmentally sensitive projects, such as shale gas, mining, landfill and nuclear sites investigations, cannot be over-emphasised. Sampling results, e.g. chemical analyses of water or soil, must be

backed by a rigorous, documented protocol and quality control process. This is required to ensure that EIAs, licence applications and site rehabilitation, for example, cannot be negatively affected by aspersions cast on the validity of key sampling rounds and results.

A suggested sequence of actions in designing such a credible sampling programme is as follows:

- Planning. What is the reason(s) for the sampling? Where should sampling stations be installed, how many, when and how often should they be sampled, and for what parameters?
- Drawing up a sampling protocol. This document is fundamental to a successful sampling programme. It must contain all the information required by the sampler to enable him/her to take samples from the correct sampling stations, using the correct sampling equipment and in a repeatable manner. It must contain basic information such as site layout, GPS coordinates of the stations and the equipment required such as keys, instruments to record field parameters, sampling receptacles, any sample preservation reagents required, field parameters to be measured, and must be taken to site on each sampling run.
- Secure storage, calibration and checking of sampling equipment. A record of calibration results must be kept.
- Quality control. This should include *inter alia* random checks on the field sampling procedure and sign-off of data sheets after 'sanity' checks by the project manager, the taking of duplicate and 'trip-blank' samples to test the accuracy and repeatability of laboratory results.
- Peer review, if necessary.
- Preservation of results in a suitable electronic database, with back-up.

A certificate of analysis from a laboratory should never be accepted at face value just because it comes from a reputable, accredited laboratory, but should be inspected carefully. For a water sample, this inspection should include 'sanity' checks on e.g. ionic balances (<5% difference acceptable but likely to be higher on low TDS samples), making sure that the electrical conductivity or total dissolved solids tally reasonably with addition of the listed concentrations of the main



ions and that there aren't any results that appear to be 'outliers' to what might be expected.

Conclusions

The key points arising from this very brief summary of a robust sampling programme are that it must:

- Be scientifically based;
- Follow a written protocol, which is taken into the field, so that sampling is repeatable; and
- Be strong on quality control measures.

To finish off, an appropriate aphorism regarding sampling and the credibility of results is, "What you get is what you inspect, not what you expect."

References

Specialist groundwater reports for various EIAs including those for Eskom's Nuclear-1, Tasman-Lukisa's uranium prospects and Shell's shale gas exploration application.

Representative Sampling – Why and How. A look at the need and the available resources.

Maggi Loubser
University of Pretoria

Introduction

Chemical analysis forms the last step in data generation, involving a miniscule aliquot taken from sample assumed to be representative, involving a potentially long and detailed sample collection and preparation history. Enormous effort is often put into the final analytical process without due consideration of the sampling steps preceding it. For accurate uncertainty estimates of the data it is crucial that the primary sampling and sample reduction steps are included in the process. Unless effective quality control systems are in place, large quantities of unreliable data can be generated. A great example to illustrate this is a dataset well-known to geostatisticians; the GASA dataset (GASA, 1997) which can be accessed from online open source platforms. Figure 1 represents this dataset.

In this example 66.7 Mt of reef is sampled in 27 boreholes. Each borehole consists of a metre of NQ (46 mm) drill core, giving us a total of 27 m of drill core. At an average bulk density of 2.78 g/cm³ this gives us 4.62 kg of rock per borehole. This adds up to 127 kg of rock

from 66.7 Mt of ore. In the laboratory we typically use a 30 g subsample of pulp for XRF analysis, thus 810 g of pulp represents 66.7 Mt of ore. In other words, 0.00000000012% of the total ore body mass is sampled and assumed to be representative.

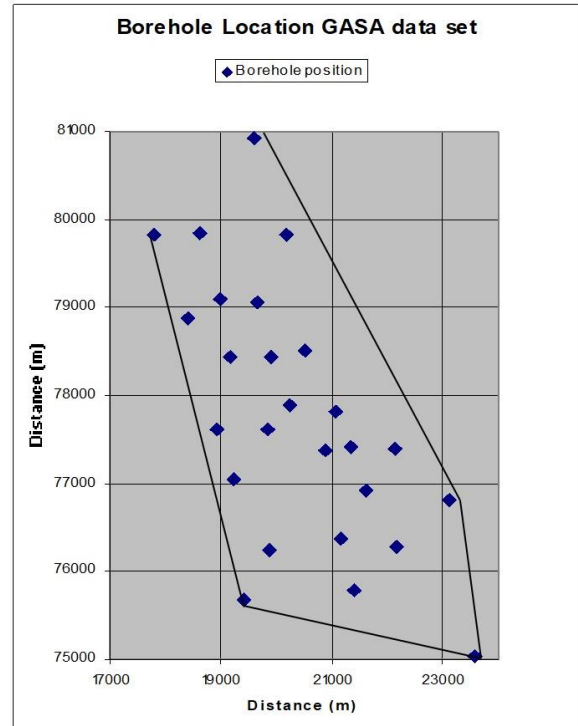

Figure 1. GASA dataset showing the spatial distribution of boreholes delineating an orebody.

In addition, this assumes that within the aliquot analysed, the analyte is homogeneously distributed. Figure 2 shows a representation of 5000 g/tonne, and the plastic beads were manipulated to be easily visible. Taking a grab sample may present you with a concentration of percentages or nothing at all. Now substitute your own analytical uncertainty into this, and the price per tonne of your commodity, and the actual cost of inappropriate sampling becomes clear.

Representative Sampling

Primary sampling (mine, stockpile, plant) and laboratory procedures (sub-sampling, mass-reduction, sample preparation) do not receive the appropriate attention in many standards and normative documents – and where included, are often based on a partial, or misunderstood basis. For economic and technical reasons, it is necessary to rely on a limited number of small samples to assess and control the basic material quantity. Truly representative sampling is a myth. Uncertainties associated with the processes will always be present, but, if they are well understood, not only can sampling errors be minimised, but the

uncertainties can be accurately estimated to be included in uncertainty estimations of the data (Ramsey, 2010).



Figure 2. A flask containing inhomogeneously distributed yellow beads in a ratio of 5000 g/tonne, or 5000 ppm.

Theory of Sampling

Figure 3 represents primary sampling with the picture of a bucket, to reflect haphazard grab sampling of a stockpile - no increase in precision in the subsequent steps can ever compensate for errors in the primary sampling step. Representative sampling is never a one-step process (grab sampling or spot sampling), but a multistep process consisting of primary sampling and representative mass reduction. Pierre M. Gy (1976) introduced the Theory of Sampling in the 1950s and applied it to many industries, but in many instances, people were and are still intimidated by the statistics and mathematics underlying it and revert back to experimental approaches.

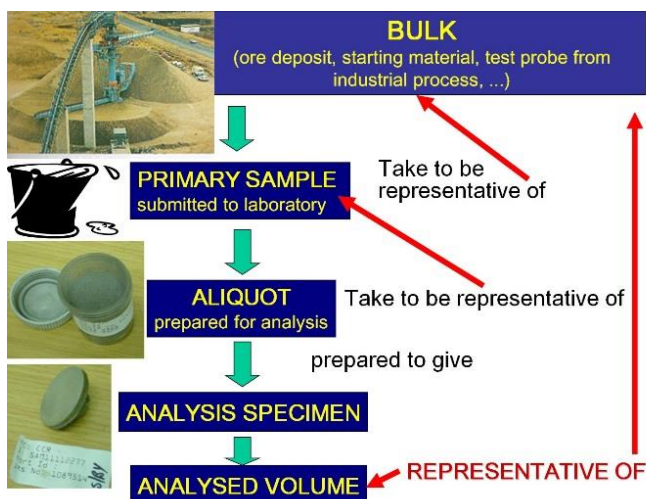

Figure 3. Flow diagram reflecting haphazard sampling of a bulk mine dump using a bucket, assumed to be representative of the dump, and further reduced in volume to prepare an aliquot for final analysis.

The process of sampling also introduces additional errors, and only by understanding how they originate

can they be limited. The Theory of Sampling (TOS) as expounded by Petersen et al. (2004, 2005), Pitard (2009), and many others, describes all the possible errors involved in sampling heterogeneous materials (in other words, ALL materials), and provides the tools for the evaluation and reduction of such errors. TOS is a combination of the sampling process and the statistical evaluation of the sample and sampling process and can appear intimidating to the uninitiated. But, if explained in a systematic manner without intimidating the reader with the underlying statistics, the necessary understanding is easily obtained, and serves as motivation to progress to the statistical calculations. It is impossible to do justice to this field in a few pages, but excellent resources are available. A series of open source columns on the topic, was published by Spectroscopy Europe between 2014 and 2020 (Esbensen et al., 2014-2020) with the aim of providing a road map for representative sampling in an easily digestible format, whether from a technical or business/commercial view. Complementary to that, in an attempt to reach a wider audience, the same author recently published an introductory sampling self-study book (Esbensen, 2020).

Conclusion

Inspection of a sample can never determine whether it is representative, only a systematic qualified sampling process can provide representative samples. Representative samples are the only way to produce representative data, and the example mentioned here should indicate how crucial that is and how far reaching the financial implications of ignoring sampling uncertainties are. Beginners often feel overwhelmed by the mass of literature on the topic, which often includes complicated statistics. With a stepwise process, first developing the individual’s understanding of the Theory of Sampling, and then progressing to the practical application both in primary sampling, as well as sub sampling in the laboratory, the “most” representative sample can be obtained with definite procedures to calculate the uncertainties.

References and Resources

Esbensen, K.H., et al. 2014-2020 Sampling Columns. Spectroscopy Europe Asia.
<https://www.spectroscopyeurope.com/sampling>
 Esbensen, K.H. 2020. Introduction to the Theory and Practice of Sampling. IM Publications Open.
 GASA (1997) GASA <http://www.kriging.com/datasets/> [2020 August 20]

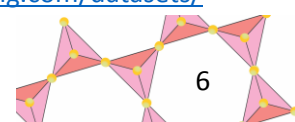

Gy, P.M. 1976. The sampling of particulate materials – A general theory. *International Journal of Mineral Processing*, 3(4):289-312.

Petersen, L., Dahl, C.K. & Esbensen, K.H. 2004. Representative mass reduction in sampling—a critical survey of techniques and hardware. *Chemometrics and Intelligent Laboratory Systems*. 74:95– 114.

Petersen, L., Minkkinen, P. & Esbensen, K.H. 2005. Representative sampling for reliable data analysis: Theory of Sampling. *Chemometrics and Intelligent Laboratory Systems* 77: 261– 277.

Pitard, F.F. 2009. Pierre Gy's theory of sampling and Ingamells' Poisson Process Approach. Pathways to representative sampling and appropriate industrial standards. Doctoral Thesis. Aalborg University.

Ramsey, M. H. & Boon, K.A. 2010. New Approach to Geochemical Measurement: Estimation of Measurement Uncertainty from Sampling, rather than an Assumption of Representative Sampling. *Geostandards and Geoanalytical Research*, 34(3): 293-304.

Some considerations for use of fusion discs and pressed pellets in routine XRF analysis

David Long

Sci-Ba

(Analytical laboratories, South Africa)

X-ray fluorescence spectrometry (XRF) is a relatively inexpensive technique capable of making traceable, quantitative measurements in both solids and liquids for a wide range of elements (generally Na-U), and is good for concentrations ranging from a few parts per million (mg/kg or mg/L for solids and liquids, respectively) through to 100% (by weight or volume). The technique does not require daily calibrations and can be fitted to automated circuits for fast and efficient analysis. The many advantages of XRF has meant that this technique is widely accepted and forms the cornerstone of many quality assurance geochemical laboratories. However, XRF does have its downsides and there are several considerations that need to be made when developing an analytical program. One such consideration is the preparation of the sample, commonly as fusion discs or pressed pellets, although some other choices exist.

As the name indicates, and at its simplest, XRF involves irradiating a sample with primary X-rays which in turn interacts with the atoms in the sample, causing electrons to 'jump' between various energy levels that result in the production of secondary (fluorescent) radiation. The fluorescent radiation is measured by a detector and through a calibration process, a concentration for a specific element can be calculated. The key interactions are between the primary and fluorescent X-rays with the sample, which introduce the concepts of matrix and particle size effects. Matrix effects result for the interaction of the fluorescence radiation with other atoms in a sample that cause samples of differing mineralogy to behave differently during irradiation. Particle size effects, on the other hand, are the interaction of the primary (and fluorescent) X-rays to topography along the sample surface resulting from particle morphology.

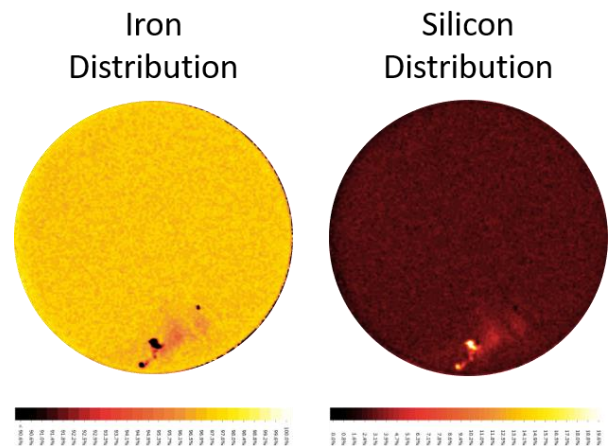
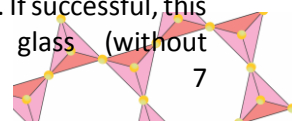

Figure 1. μ -XRF Elemental Map of Fe and Si in a fusion disc (SARM-132).

Generally, there are two methods to prepare samples: fusion discs (or beads) and pressed powder pellets. Pulverized solid samples are pressed into powder pellets using a hydraulic press, most often with the aid of a binder. The process of pulverizing reduces the particle size of the sample but maintains its mineralogical nature. Although, a very quick, easily automatable and inexpensive technique, the surface of the pressed powder pellet maintains a topography and each particle maintains its mineralogical nature, thereby both matrix and particle size effects are present during analysis. On the other hand, fusion discs involve the dissolution of sample into a flux (typically a lithium borate) at high temperature in an induction field, gas burner or muffle furnace before being cast into a mould and being rapidly cooled. If successful, this process creates an amorphous glass (without



mineralisation) and the cast surface has minimal topography, thereby removing both matrix and particle size effects from the analysis. When done successfully, XRF analyses performed on fusion discs generally exhibit better precision and lower expanded uncertainties compared to their pressed pellet equivalents, and therefore in theory, it sounds logical that preparing fusion discs should be the preferred methodology. However, in practice, preparing fusion discs can be complicated, expensive and unless working with a consistent matrix type, can be fickle.

The main problem is that working with an oxidising system (e.g. lithium borate flux), platinum-ware is required to melt, agitate and cast the liquid. This represents an expensive initial purchase that is a high-risk metal for theft. In addition, platinum-ware should be considered as a consumable (i.e. high operating costs) and requires an appropriate management program (and adequate budget) to be set in place. For example, platinum crucibles should be clear of dents and scratches that can contaminate or affect the dissolution and agitation process, and the platinum moulds should be clear of scratches, warping, pitting and denting that would otherwise affect the topography of the analytical surface.

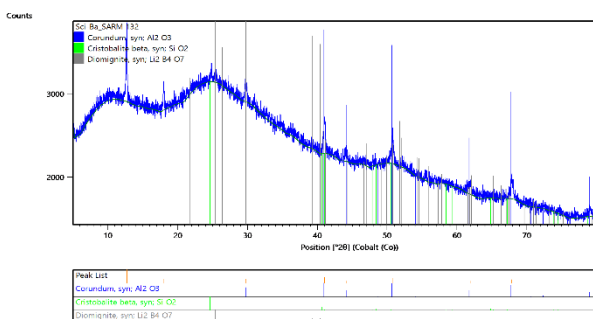

Figure 2. XRD Diffractogram of a SARM-132 fusion disc (XRD Analytical & Consulting cc).

There are other problems, but generally these can be addressed at the method development and calibration stage. For example, the appropriate choice of flux to use should be made when designing the method and based on experimentation. There are multiple suppliers and types of flux with differing ratios of lithium (or sodium) meta- and tetraborate with or without oxidising and releasing agents. The choice of flux, and the dilution ratio of flux to sample, will depend on the mineralogical nature of the sample and the elements of interest. Other important parameters to consider are heating rates (ramp times), residence

and agitation times, cooling rates etc. The objective is to create a completely amorphous, well cast fusion disc with a 'polished' analytical surface.

It should be noted that fusion discs do require a much higher dilution than pressed powder pellets. Fusion discs are 'generally not useful' for detailed minor to trace element analysis. As much as this is a broad statement, there are several caveats that need to be considered such as the analyte in question, the expected concentrations of analytes of interest, the power of the X-ray tube and other hardware in the XRF spectrometer being used.

There are several tables, resources, and tools available to help choose the most appropriate flux and fusion procedure, however, it is best to follow the theoretical approach with experimentation and to pull on other analytical techniques for verification. For example, XRD can help identify any crystals present in the disc and mapping techniques such as μ -XRF or SEM can be used to identify chemical heterogeneity within a fusion disc.

Just like all analytical techniques (and sample preparation procedures), each has their appropriate place, and brings with it some pro's and con's. The choice of XRF procedure to use should be based on the laboratory's objectives and criteria and these should be decided at the start of the development of an analytical method. Some examples include, where budget or security is a concern or in the situation of a quality control laboratory that may only be interested in batch-to-batch variation (trueness is less important and relative data is very important) then perhaps pressed powder pellets is the more appropriate choice. Alternatively, if the method needs to comply to a standard method (e.g. ISO 9516 for analysis of iron ore) then analysis shall only be performed on fusion discs.

Whether pressed powder pellets or fusion discs are used in routine analysis, XRF is a technique that can provide a laboratory with many years of excellent data and service with minimal involvement as long as due diligence is performed upfront at the design and development stage and procedures (and budgets) are put into place for maintenance of the method and equipment.

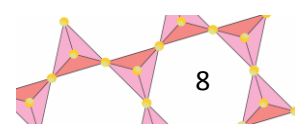

Struers Mineralogical Sample Preparation

Struers ApS Pederstrupvej 84 DK-2750

Ballerup, Denmark

Thin Sections

The production of thin sections requires highly specialised equipment. Struers has developed the TS-Method™, a technique which provides outstanding quality and very high reproducibility and it is very easy to use.



Our friend, the petrographic microscope.

Polished Sections

The preparation of mineralogical specimens for microscopic examination in reflected light is basically similar to the preparation of other materials.

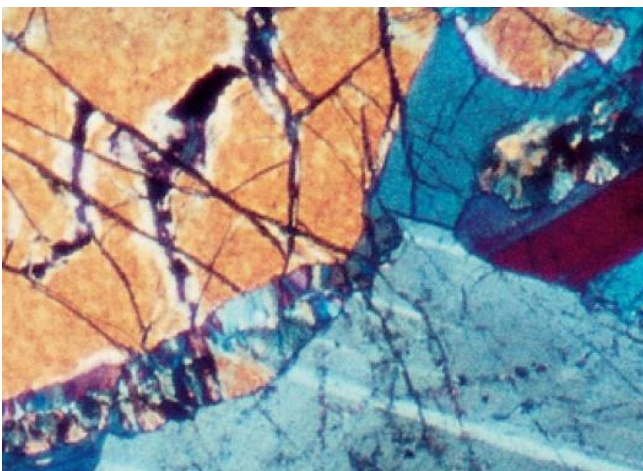

An example of a polished section: looks like one of my personal favourites; coronitic orthopyroxene ± clinopyroxene growing at an olivine-plagioclase interface (editor’s note).

After cutting, the specimens are normally mounted in the vacuum impregnation unit CitoVac using EpoFix resin. Lapping is carried out on LaboPol-30/LaboForce-Mi by means of a cast iron lapping disc and the composite disc MD-Largo. The abrasives used are SiC powder and diamonds. Grinding, lapping and polishing can also take place on either semi-automatic or automatic preparation equipment.

Struers Mineralogram – “Mineralogy Methods Cube”

The Methods Cube covers standard thin section preparation methods for a wide range of minerals. It was developed in collaboration with GEUS (The Geological Survey of Denmark and Greenland).

Visualization of our Cube:

Along with GEUS, it was determined that a cube would provide the best representation of mineral properties. The cube is divided into three two-dimensional squares to make it easy to work with and understand.

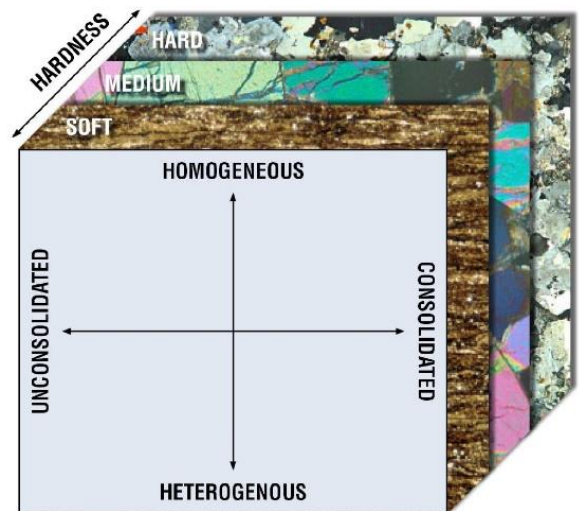

The hardness of rock is a term that can be difficult to handle, because rocks are a kind of “composite” (and a mix of minerals with potentially different hardnesses). Important rock parameters, both alone and in combination with others, are internal structure (column equality, slate-like cleavage), and the extent to which the rock has been subject to pressure, and/or (partially) converted by various liquids or molten rock.



A rock may encounter isotropic properties that must be assessed for each specimen by looking at the mineral along with the general structure of the rock and considering whether there are other conditions that may affect the hardness.

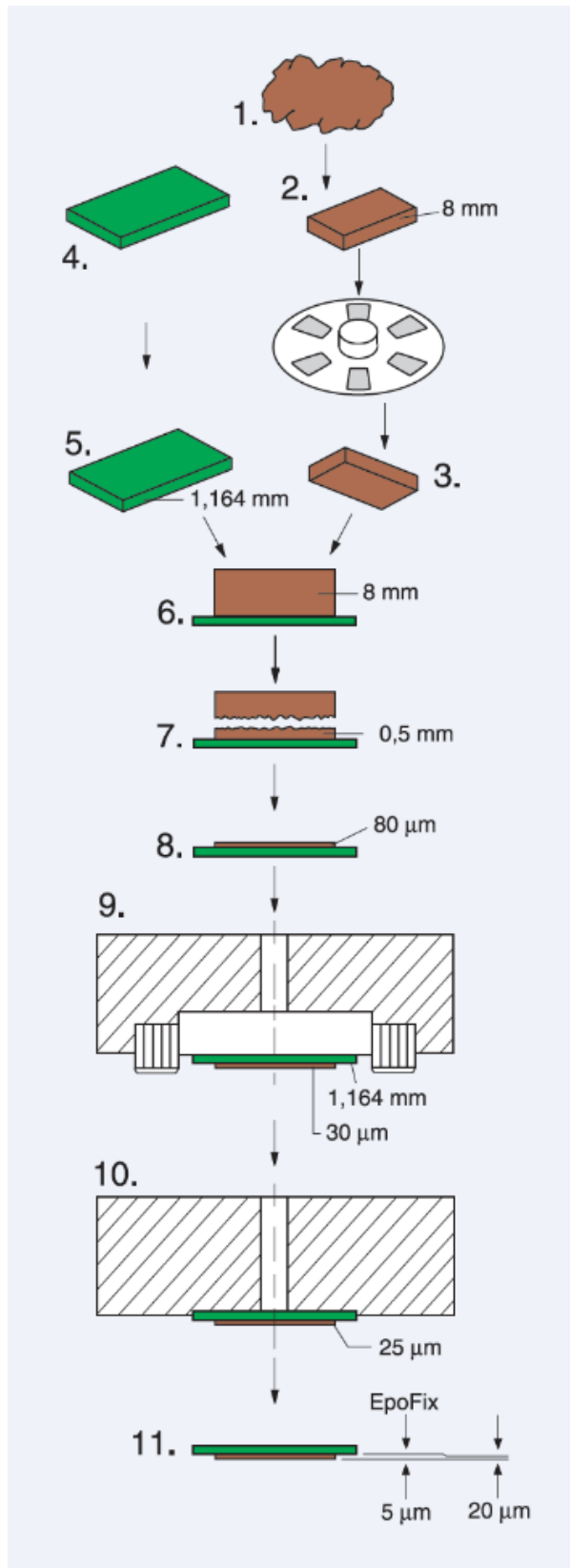

The TS-Method™ for preparation of thin sections

1. Sampling.
2. Cutting of a specimen on Accutom-100.
3. Automatic lapping of the specimen on LaboPol-30/LaboForce-Mi lapping/polishing machine.
4. Glass slide 27 x 46 mm or 28 x 48 mm.
5. Grinding of glass slide in Accutom-100 to a given thickness, e.g. 1.164 mm.
6. CitoVac vacuum impregnation unit: cementing of specimen to glass slide using EpoFix resin.
7. Accutom-100: cutting off surplus specimen material to a thickness of 0.5-2 mm.
8. Accutom-100: grinding of thin sections to a thickness of 80 µm (section + EpoFix resin).
9. Automatic lapping of thin section in BORTY thin section holder on LaboPol-30/LaboForce-Mi. Final thickness of section + resin e.g. 30 µm.
10. Automatic polishing of thin sections in TYNDS thin section holder on LaboPol-30/LaboForce-Mi. Reduction for a typical polishing: approximately 10 µm.
11. The specimen is now finished. Thickness: 20 µm.

Thoughts on the potting and sizing of particulates mounted in 30 mm epoxy resin impregnated sample blocks typically used for Auto-SEM-EDS analysis

Igor Tonžetić
University of the Witwatersrand

Are bubbles in a 30 mm epoxy resin sample block really a problem? Or are bubbles on the surface which is to be analysed a problem? This is a non-trivial distinction. If one feels that the former is a problem, then gentle mixing of the sample is probably requisite. If one feels that the latter is a problem, then vigorous mixing of the sample (to make the air bubbles rise away from the surface to be analysed) is probably requisite. Regardless of the two hypotheses (which could prove interesting research opportunities), it is my experience that if one undermines the sample (Figure 1) while potting (mixing with resin), no matter how fast one mixes, one can mix the sample with minimal bubbles.

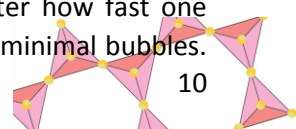

The practice of leaving particles to settle in the resin by some laboratories, definitely aids this process. Placing resin in pots before placing the particulate sample in also appears to aid this process since it is the bottom of the cast (in contact with the bottom of the mould) that will eventually get analysed and doing this in this order allows for the bubbles never to form in the first place (allows for air escape).

It would also, in principle, be easier to undermine the sample with slanting pots (as shown in Figure 3). This however necessitates a change in the sample block holders that are currently used in Auto-SEM-EDS instruments (probably necessitating the re-engineering of said sample block holders – few laboratories have access to onsite engineering capabilities). The amount of resin used also seems to affect bubble formation with either a touch too little (undersaturation) or a touch too much (oversaturation) being optimal to minimize bubble formation.

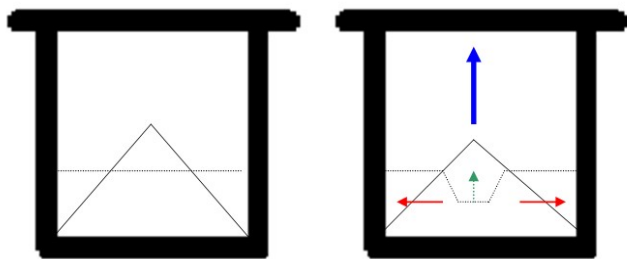

Figure 1. Undermining of sample being potted. The procedure forces the resin to re-equilibrate to its former surface level, thus forcing air (blue arrow) out of the sample. Red arrows indicate lateral movement of sample. Green arrow represents re-equilibration. Stippled line = resin level.

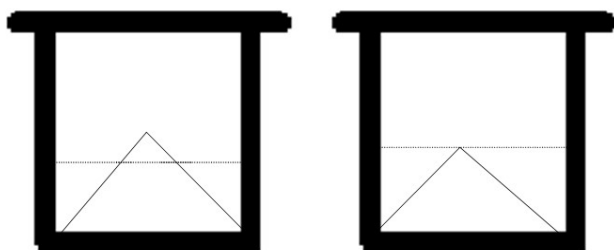

Figure 2. Oversaturation of sample with regard to resin. At left, sample is saturated. At right, oversaturated. Stippled line = resin level.

As it turns out, this often happens accidentally – probably because of variations in the amount of graphite that gets added to ensure particle separation.

Perhaps a touch too little inhibits air bubbles from being formed (effectively squeezing them out?) whilst a touch too much gives the sample more resin to soak into.

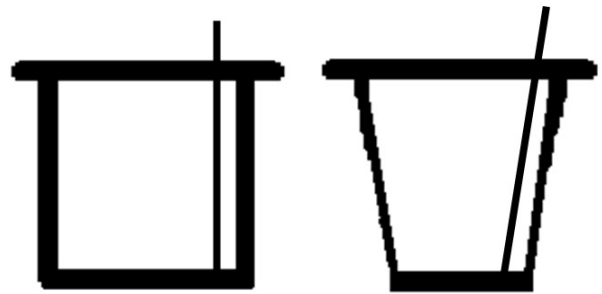

Figure 3. Relevance of pot shape: at left, a straight-sided pot, and at right, a slanting-sided pot, allowing for the undermining of samples.

To my knowledge, the jury is out on whether potting in a vacuum (to expedite bubble formation which then moves to the top of the sample and eventually out from the sample) or pressurized vessels (which would inhibit bubble formation in the first place by curing at high pressures thus preventing their formation in the first place) is better. Although once again the non-trivial distinction in my problem statement about bubble formation perhaps suggests which is better.

Problems in the size (height) of the samples, because of under backfilling or over backfilling, can (in principle) be easily rectified with calibrated (or colour-coded?) sample pots up to a certain height. To affect a change with regards to this probably would only entail convincing certain suppliers to manufacture these pots with said changes. But certainly the last thing needed in a measurement run is a sample block that moves around in the sample block holder (in practise this seldom occurs) because the springs that ensure the sample block is pressed against the lip of the holder can barely reach it; or not being able to run the samples because the sample block holder cannot be closed due to over thickness (more common).

In previous laboratories that I have been exposed to, small, manual, hand-held printing labellers have been used to label samples, with a minimum of cutting needed to get them to fit within sample moulds. A distinct advantage is the fact that sample labels are then always readable, no matter the technician responsible for them.

Another difference between labs with regards to potting is the use of mixing/stirring implements. Some labs use kebab or “sosatie” sticks for stirring and consider them disposable items, naturally minimizing sample cross-contamination. Some use and re-use wire implements, being both cheaper to utilize and more sustainable.

To minimize contamination between sieves for creating size fractions, the extraction and weighing of particles (and cleaning of sieves), should begin with the smallest sieve sizes and proceed to the larger ones, since a single large particle contaminant in a specific number (“x”) of small particles represents a larger degree of contamination (both in terms of surface area percent and weight percent) than a single small particle in a specific (“x”) number of large particles (see figure 4). The use of an air gun for the cleaning of sieves may further lesson contamination rather than the use of nail brushes or paint brushes. The use of rubber “agitation” balls (used to ensure particles not being stuck in apertures) may result in samples losses (and contamination) since they appear to be quite porous and may even have electrostatic affinities to certain minerals (and hence particles). They prove to be quite difficult to clean at times but washing in ultrasonic baths and subsequent weighing may be an approach to see if this is indeed the case.

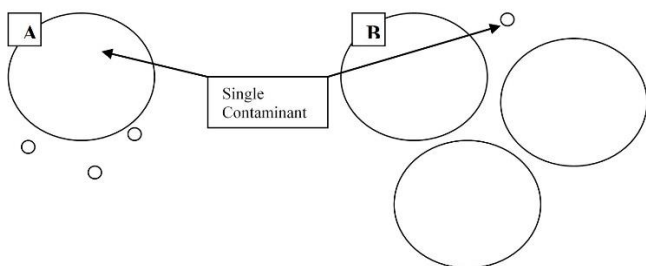

Figure 4. Relevance of particle size vs % of particles in terms of proportion of contaminant. Both populations can be described as 25% contaminated (1 part in 4) in terms of particles, but sample at left is >90% contaminated by volume, whereas sample at right is <5% contaminated by volume.

Secondary Ion Mass Spectrometry (SIMS) sample preparation: key guidelines for preparing good quality samples

Sarah Glynn ^{1,2} and Michael Wiedenbeck ^{2,1}

¹ University of the Witwatersrand

² Helmholtz-Zentrum Potsdam Deutsches GeoForschungsZentrum (GFZ)

SIMS is a technique which allows for highly precise chemical or isotopic analysis of samples on the micro-scale (Stern, 2009); in order to accomplish this, it requires careful attention as to how the samples are prepared. This is because of how SIMS generates secondary ions – the sample’s surface is itself a component of the ion optics. Hence, any sample topography can have an adverse effect on data quality. Consider figure 1 below: the primary ion beam (red) comes in at 25° to the sample surface and the secondary ions (blue) are accelerated away from the sputtered crater perpendicular to the sample surface. It is therefore evident that samples with even moderate topographic relief will direct ions into the mass spectrometer off the optic axis of the system, and this will ultimately result in poor data reproducibility. However, in order to avoid scenarios such as this, some key guidelines to keep in mind when preparing a SIMS sample have been listed below.

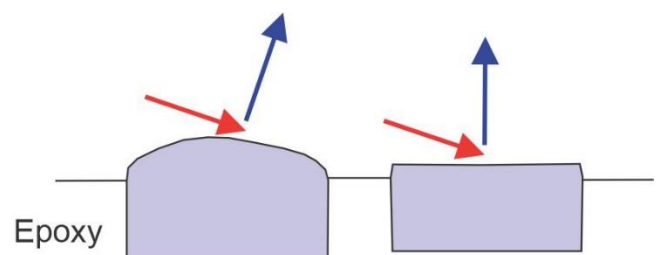
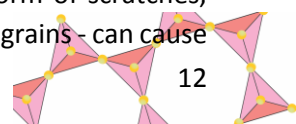

Figure 1: sketch depicting how sample topography affects the trajectory of the secondary ions, after Valley (2013).

The first things to consider are that the sample be:

- Solid
- Polishable (i.e. you should be able to polish it flat to a mirror finish, with minimal scratches)
 - As has already been established, sample topography can impact the signal, but negative relief - in the form of scratches, pits and trenches around grains - can cause



sample charging as these features (particularly if very deep) may not be properly gold coated prior to analysis.

- The sample must be able to be coated with an electrically conductive film: typically, a 35 nm, high-purity gold film is used in the Potsdam SIMS lab.
- Clean
- Vacuum compatible
 - These last two points go hand-in-hand, because samples need to be as clean as possible in order to minimise outgassing. SIMS instruments operate under high vacuum; so, when a sample outgasses, the vacuum quality drops as there are now additional unwanted ions and the resulting collisions between ions can knock those of interest off course. This problem can be minimised however, by firstly ensuring that the samples are clean before going into the instrument and if possible that they are not made up of large amounts of epoxy (which itself must be vacuum compatible).

There are various ways to prepare samples so as to limit the amount of epoxy used. For in-situ work, a thin section or rock chip are ideal and for individual grains an epoxy disk or preferably a drilled out acrylic disk (see figure 2) can be used. It is important to note that the sample format for SIMS is round, with a diameter of 25 ± 0.5 mm (i.e. 1 inch), and should be no taller than 11 mm, but between 4 and 7 mm is ideal. In cases where really minimal outgassing can be tolerated, for example when analysing hydrogen content in nominally water-free mineral phases, it might be necessary to use a non-organic embedding material such as indium metal or a wood-metal alloy.



Figure 2: some examples of the acrylic disks commonly used by the Potsdam SIMS lab.

Two additional key guidelines to remember when preparing a SIMS sample is to wherever possible a) ensure that the points of interest/ grains to be analysed are within 8 mm of the centre of the sample and b) that it is often advantageous that the relevant reference material be mounted alongside the unknowns. Both of these are particularly crucial when it comes to isotope work as it can result in significant isotopic ratio bias at the per mil level (parts per thousand) if sample changing is necessary. The reason for having the points of interest as centrally located as possible is because the centre is generally the area of a sample where it is the most likely to be flat. It is also because the automatic centring routines are less effective near the edges of the sample mount; being even within 4 mm of the edge of the sample holder results in disrupted electric field lines, leading to uncontrolled isotopic fractionation.

Having the reference material within the same mount ensures that both the reference material and the unknowns are measured under identical analytical conditions.

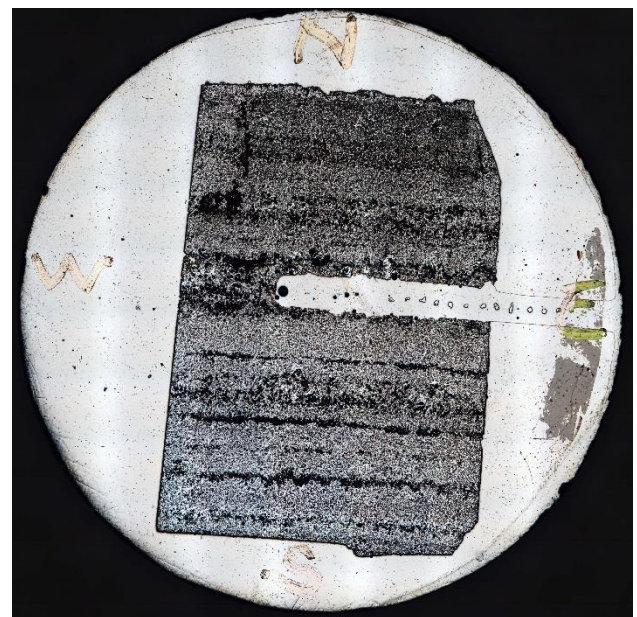

Figure 3: Reflected light overview image of a rock chip which was co-mounted with a few grains of the relevant reference material (in the slit on the right).

SIMS instruments have space in the sample chamber for only one sample, so if the reference material is not mounted along with the sample, there needs to be periodic exchanges between the sample and standard mount. In doing so, the analytical conditions vary ever

so slightly each time the exchange is made and this can impact the results. As a secondary benefit, having the reference material mounted with the sample, means that analyses can be carried out remotely – this is important for the GFZ-Wits virtual SIMS facility as it ensures that work can easily be done remotely.

Finally, when it comes to SIMS sample preparation, it is important that all samples be carefully documented prior to submitting them for analysis, this includes making note of sample names as a single mount may contain multiple samples. It is also crucial that the user be familiar with the sample so as to easily navigate to points of interest. In Potsdam we take a reflected light overview image of the sample (such as the one in figure 3), using a motorised petrographic microscope to aid in navigation. Other important tasks prior to SIMS analysis include:

- Acquiring reflected and transmitted photomicrographs of the points of interest, as once the sample is gold coated it becomes difficult to identify features like grain boundaries or mineral phases.
- Scanning electron microscope images for secondary electron (SE)/ backscattered electron (BSE) and/or cathodoluminescence (CL). This is particularly important ahead of doing U-Pb dating of zircon for example.
- Electron probe EDX analyses are necessary of each point of interest which is to be measured as part of trace element work.

Additional resources and references:

<http://sims.gfz-potsdam.de/sample-prep/>

Stern, R.A. (2009). An introduction to Secondary Ion Mass Spectrometry (SIMS) in Geology. In: Fayek, M. (Editor), Secondary Ion Mass Spectrometry in the Earth Sciences: Gleaning the Big Picture from a small spot. Mineralogical Association of Canada Short Course, volume 41, 1-18.

Valley, JW. (2013). Workshop on High Resolution Proxies of Palaeoclimate.

Controversial contrarian concepts to consider when you're in a sample preparation bind

Igor Tonžetić

University of the Witwatersrand

In a paper I presented at the 35th International Geological Congress (back in 2016), I argued, perhaps controversially that it was possible to bring down the costs of block mounting sample preparation (specifically for the Auto-SEM-EDS industry) from the almost R500 being offered by commercial laboratories at that time (and the R165 being offered at some universities) to around R30 (“a reduction in costs from between a factor of 5.42 and 12.05” – Tonžetić, 2016). To be fair, some of this reduction came at the expense of increased time, increased physical labour (less automation) and some creative ways of inducing cheap labour. Regardless, it was shown that alternatives could be utilised in for instance:

- Grinding & polishing – Hardware store sand/corundum/carborundum paper sheets vs polishing/grinding machines and their cloths and laps
- Carbon coating – Graphite pencils vs vaporising carbon coaters
- Mounting media – Conventional everyday resins vs Commercial sample preparation resins
- Moulds – Freely available (often discarded) disposable 30mm capsule/pill holders vs conventional sample preparation moulds
- Labour – Internship style sample preparation technicians vs permanent sample preparation technicians
- Cutting/Slab making - Hardware store diamond coated discs and bench cutters vs high precision ultra-safe cutting machines

The cost savings translated to something like (at 2016 values ZAR):

- Grinding & polishing – Primitive techniques ZAR 3.74 vs Advanced mechanical ZAR 46.01
- Carbon coating – Primitive techniques ZAR 0.00002c vs Advanced mechanical ZAR 0.42
- Mounting media – Primitive techniques ZAR 2.79 vs Advanced mechanical ZAR 22.85
- Moulds – Primitive techniques ZAR 0.00 (Free) vs Advanced mechanical ZAR 0.69

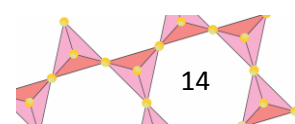

- Labour – Internship style ZAR 21.81 vs Permanent technicians ZAR 375.00.
- Cutting/Slab making - Primitive techniques ZAR 2.12 vs Advanced mechanical ZAR 28.94.

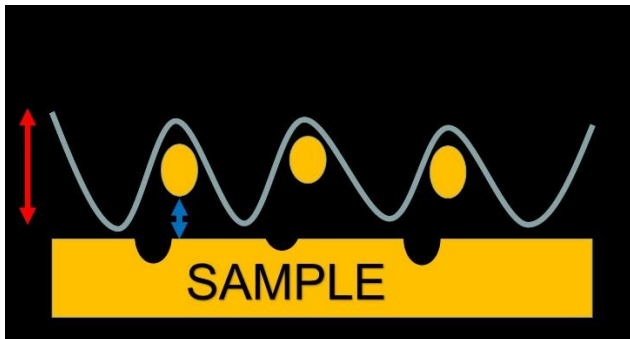

Figure 1: Schematic of “dry” (no water) particle abrasion in grinding and polishing. Double red arrow represents apparent, stated grit size of abrasive paper. Double blue arrow represents resultant, affective grit size of abrasive paper. Yellow ovals are “trapped” particles abraded from prepped sample. Wavy grey line represents abrasive paper with the amplitude of its apparent grit size.

The “primitive techniques” constitute the manual, labour and time intensive way of doing things (the “former” methodologies presented with the first bullet points) whilst “advanced mechanical” constitute the default automated way current laboratories work (the “latter” methodologies presented with the first bullet points).

Whilst the paper was not intended to be any kind of value or quality statement on the “primitive” way of doing things versus the “advanced”, a few things bear mentioning. For instance, since the grinding and polishing steps performed on the sample presented were “dry” (no water was used to remove abraded particulate stemming from the sample) the true fineness of the polished surface ended up being finer than any stipulated “grit” size of abrasive (sand-, corundum-, carborundum-, garnet-) paper used. Intuitively this makes sense since because the abraded particulate is not being removed from the grit paper, the “amplitude” of the “sandpaper” grit is reduced (Figure 1). Anyone, for instance, who has attempted to grind a quartz pebble on a bench grinder (no matter the grit of the grinding wheel) has quickly discovered how smooth the grinding wheel becomes (not because the wheel grit gets finer - a physical impossibility since quartz is softer than silicon carbide – but because fine

quartz gets trapped in the grooves of the grinding wheel). They have also consequently discovered how difficult it becomes to grind the quartz pebble any further...and also how hot the wheel (and motor) becomes due to friction. It is the fundamental reason why lapidary wheels operate with water taps to wash away the accumulated particulates from rocks being lapped. But it is also the reason why industrial advanced mechanical polishers have to go to such low grit sizes (often 1 micron deep) to obtain a fine polish. Theoretically, one would not have to go to such low grit sizes, if one’s sample preparation was dry, with a concomitant decrease in consumable costs. Figure 2 shows a BSE image of a dust sample obtained from a vacuum cleaner that was prepared “dry” at 1200 grit.

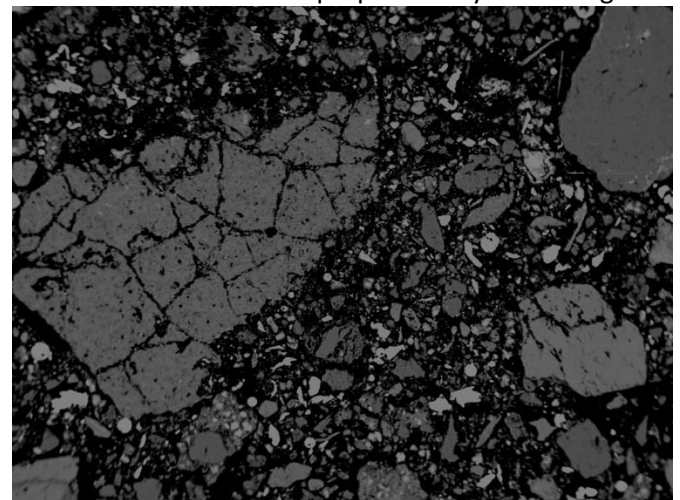
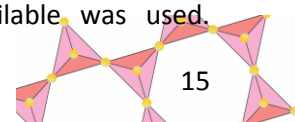

Figure 2: BSE image of a dust sample obtained from a vacuum cleaner prepared “dry” at 1200 grit. Some charging is visible top right.

The study also experimented with replacing carbon coating costs (as cheap as they were at 50c a coating) by simply “colouring-in” the carbon coating with a graphite pencil. With a little experimentation, an appropriate carbon coating thickness was obtained that allowed for SEM imaging AND automated (Mineralogic©) EDS work (Figure 3). The almost negligible costs of this derived from the following:

- Cheapest pencil: ZAR1 or 100 cents
- Average length of pencil: 15cm = 150mm = 150 000 µm
- Average carbon coating thickness: 0.025µm
- Therefore: 6 000 000 coatings per pencil
- Cost per block: 0.00002c per polished block

Once again, since the goal of the exercise was exploratory in nature with no real concern for quality, the cheapest graphite pencil available was used.



Further exploratory work would have consisted of experimenting with the different hardness's of pencil (HB, 2B, 2H etc.) though presumably the softest pencils would've been more ideal since hardness is determined by the amount of clay mixed in with the graphite which presumably would lead to contamination concerns. Of course one could simply negate the need of conducting surfaces altogether by simply running at lower beam currents or

environmental SEM capabilities (depending on the type of sample being analysed).

Reference:

Tonžetić, I.Ž. (2016) Cost comparison of sample preparation for the mineralogical community - primitive techniques vs advanced mechanical techniques; International Geological Congress Conference Proceedings.

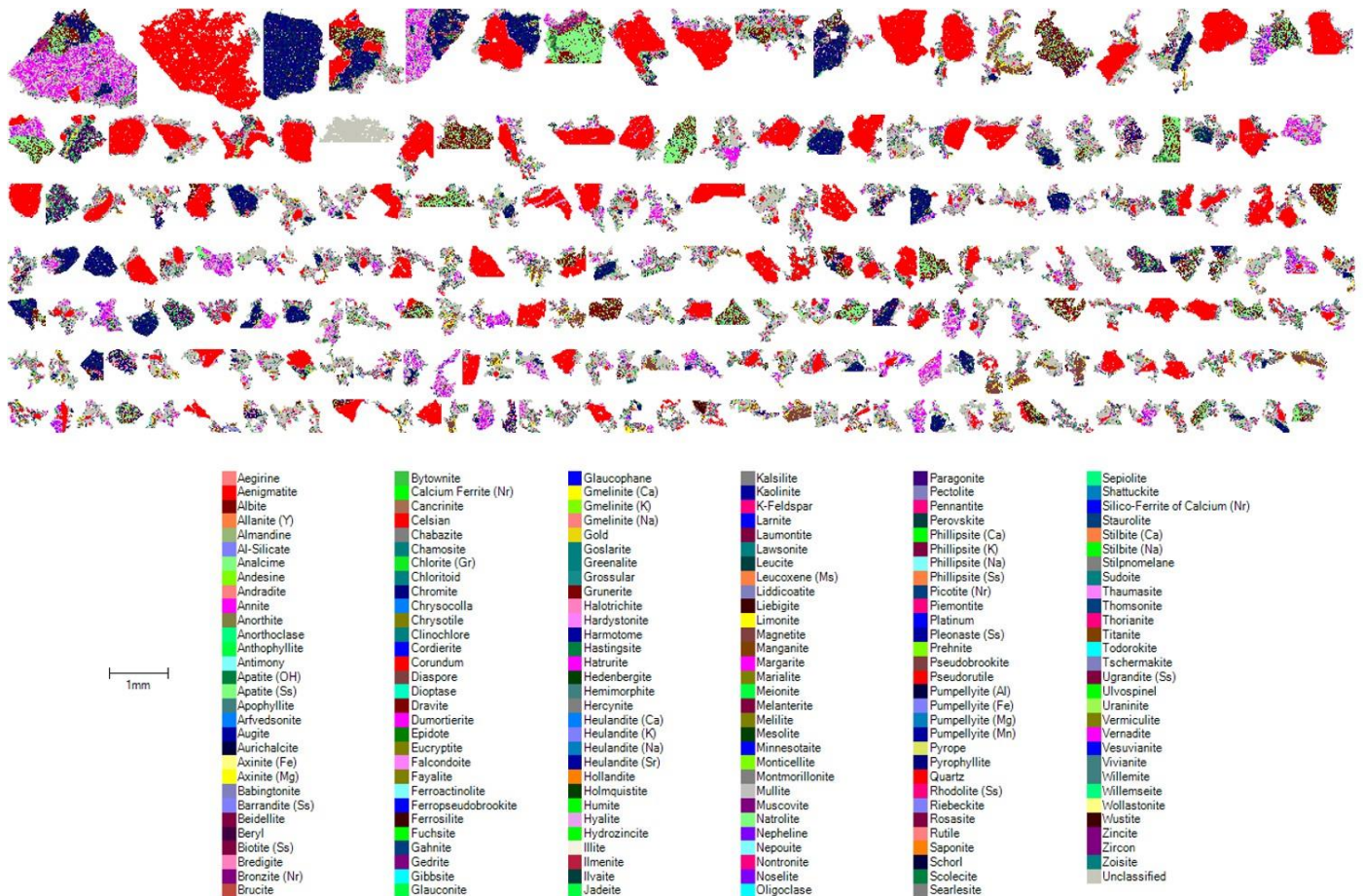

Figure 3: Mineralogic@ Auto-SEM-EDS analysis of sample from figure 2. Mostly seen is quartz (red).

The world of the micro-collector

Graham Reeks

South African Micromount Society

The world of the collector of mineral specimens can generally be divided into two types – the macro size specimens - or those generally seen in museums or personal collections and the micro size or those needing a microscope to view. The micro-mounter and the hobby of micromounting began in the USA and Canada around 50 to 60 years ago and several societies were formed such as the Canadian Micromount Society and the Baltimore Mineral Society to name just two. A

similar society was co-founded by the late Horst Windisch and myself in 1974 in South Africa and was named the South African Micromount Society.

What is micro-mineralogy? Very simply, it is the collection of very small specimens that ideally fit inside, or rather are mounted inside, a 25 mm cube plastic box with either a removable or hinged lid. Ideally the specimen is of a perfect crystal or crystals of a specific mineral species. Very often nature produces perfection in micro rather than macro form. It is this perfection of crystal form that is the ideal for most collectors. In many cases in the mineral world, crystals of a species do not grow large i.e. above 1-2 mm, these are ideal for the micro-collector. Then there are the rare species

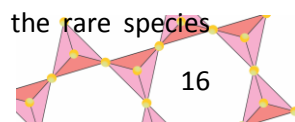

that are only found in very small pockets, growing in amongst other species in a micro-environment that is often only seen and possibly understood, when looked at under the higher magnification of a microscope. Some of my specimens are so small (< 1mm) that they consist of a single crystal mounted (glued) on the end of a thin glass fibre which in turn is glued in a piece of cork glued to the base of the plastic box.

What are the basic tools of the micro collector? I have mentioned the boxes. One also needs dental probes, tweezers, quick set thin glues, a mechanical trimmer to reduce the original rock specimen to “micro” size and of course a microscope and lamp.



Figure 1. Microscope, lamp, and tray of mounted micros.

Most people use a binocular microscope with zoom adjustments and lenses giving magnifications from 10x to 50x magnification. In my case I have additional lenses to increase the magnification to 180x magnification but that is rarely used, and usually only when trying to determine the minute crystal faces, as I have a passion for crystallography.

Once the specimen has been trimmed down to a size to fit within the box and sometimes it is only a few millimetres across it is then cleaned of dust and carefully aligned in all directions so as to give the optimal view when seen through the microscope. At that position it is glued to a small cork or stick of balsa wood which in turn is glued to the internal base of the box. After gluing it is checked to ensure that the position for viewing is correct.



Figure 2. Micromount in its labelled box.

When the specimens are mounted in their respective boxes they are then identified with a label or number and stored in trays or drawers and catalogued as the individual collector desires. The thematic and general collectors in the macro world are much the same in the micro world. In other words collectors who collect from all localities, specific localities, specific countries, specific classes or types of species i.e. copper minerals, perhaps only crystals. For most micro-mounters the joy is the perfect crystal of a species but very often it can be a ‘what is it though’ moment.

Two examples of photomicrographs of micro-mounted specimens from a historical South African tin and copper mine are shown below.

What micro-collecting does is teach you is an understanding of mineral micro-environments. For example some years ago I found micro crocoite crystals at a hundred year old silver mine on the East Rand. Many of us knew they were there along with a few other lead chromate species that had been positively identified. Could there be more? – it’s a very small family of mineral species. Research into the lead chromates and a paper on them by Williams (1974) led me on a quest. What was the vivid deep red vitreous mineral at the base of and internally of some of the crocoite crystals? Could it be the mineral described by Williams as the base of some crocoite crystals – phoenicochroite, $Pb_2O(CrO_4)$. My long time mineral friend – Roger Dixon and I made XRD and XRF tests on the material and confirmed the species. For me this was the amateur and professional mineralogical world coming together. This is what makes the micro world so exciting – the finding of new species at a site and the understanding of the micro-environment and the mineralogy of the deposit.

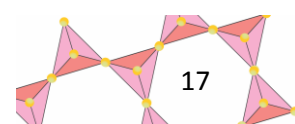



Figure 3. Olivinite $\text{Cu}_2^{2+}(\text{AsO}_4)(\text{OH})$ crystals, Stavoren tin mine, Marble Hall, Limpopo. fov. 10 mm. (Graham Reeks photo).



Figure 4. Ludlockite $\text{Pb}^{2+}\text{Fe}_4^{3+} \cdot \text{As}_{10}^{3+}\text{O}_{22}$ crystals, Stavoren tin mine, Marble Hall, Limpopo. fov. 10 mm.

One of the advantages of micro-mineral collecting is that the collection/s take up far less room than a macro-collection. The downside is you need a microscope to appreciate the specimens.

Reference

Williams, S. A. (1974) The naturally occurring chromates of lead. *Bull. Brit. Mus. (Nat. Hist.) Mineralogy*, 379-419.

A letter to the editor

Dear Steve

With regard to making pucks: I use a cold epoxy for mounting; it cures at 60°C (in an oven) but drops in viscosity before the curing occurs. This completely eliminates the bubble issue. The XRF bit is also interesting. Balz Kamber and I chatted about this several years ago: he wanted to use an Ir thermocouple

to melt material and create a fused disc. We never did do it, but the mechanics are there and are sound.

Great on the (June) crossword puzzle, although I did take offense to the comment about serpentine and cancer (mesothelioma). Living in an environment where one is exposed to high concentrations of anything (including coffee), is never good, but serpentine is not the primary cause of mesothelioma. The interesting factoid is that serpentine actually breaks down very quickly in the human body, so its residence time is very short. The real culprit here is riebeckite var. crocidolite (precursor to tiger's eye), notably that from Libby, Montana, which was marketed for decades as home insulation. That stuff has a very long residency period and is the real culprit.

Andrew M. McDonald, Mineralogist
Professor, Harquail School of Earth Sciences &
Director, MicroAnalytical Centre
Laurentian University
Sudbury, Ontario, Canada

Other Gems

The following short story was written by Louis Cabri, and published as part of a collection of reminiscences entitled "When Yesterday was Today". It is reproduced here with Dr Cabri's permission, in its original form.

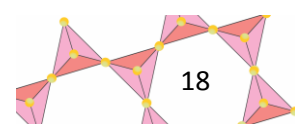
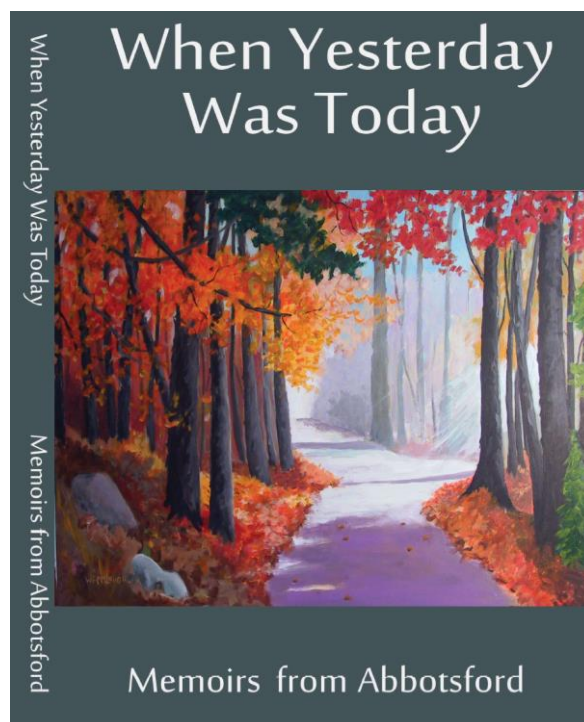



Russian Bear Hug

LOUIS J. CABRI

My first of several trips to the Soviet Union was in September 1978, at the height of the cold war, to attend an international conference in Novosibirsk, in south-western Siberia. Briefed by the RCMP, I eagerly looked forward to the trip for many reasons, including the opportunity to meet the late Alexandr Genkin, a Soviet mineralogist I respected. I had characterised and named after him a mineral new to science that I had discovered in a sample from South Africa (genkinite—a mineral containing specific proportions of the precious metals platinum and palladium, in addition to antimony).

The economy flights were tedious. After the Atlantic leg, there was a long wait in London with a colleague from Ottawa before catching the late Moscow plane. The long expressionless stare by the official in the dimly-lit customs hall was meant to intimidate and be unnerving. In Moscow, we spent the night in one of Stalin's ugly towers that passed for hotels.

The evident poverty was accentuated by the drab decor and by an attempted robbery in the elevator later that evening. By the time we checked in, we were ravenous and immediately went down to a chandelier-lit dining hall, with an orchestra which faced the tables. The room appeared like a ballroom, except for the white-clothed, round dining-room tables. The sparse

menu was in Russian, but we were able to order caviar and vodka, the former heaped in a large silver tub on ice. Staggering back to the elevators, we were joined by a stranger, who jumped in just before the doors closed. He immediately tried to steal my red ballpoint by opening my sports coat and inserting his hand to grab the pen. I managed to keep hold of it and eventually escaped on the seventh floor, one above mine, leaving my friend to deal with him. I started towards the wide marble staircase but was startled by a loud "Nyet!" barked by a formidable "floor lady" sitting cross-armed at a desk near the elevators and was forced to wait for the down elevator. I later learnt that my friend, Joel Grice, nearly lost his jeans to that stranger on his way to the eleventh floor.

Another crisis occurred early the next morning prior to departure for Novosibirsk from a different airport, adding to my anxiety: when we lined up to retrieve our passports, the hotel clerk could not find mine among two high stacks of passports. She kept on shuffling the passports, getting visibly worried, beads of perspiration forming on her brow. After what seemed like an interminable period, I spotted mine, pointed to it, and off we ran to the waiting taxi.

Novosibirsk is a large industrial city straddling the River Ob. All the western delegates were assigned to the Hotel Ob, together with Olga, an Intourist guide/ spy. We were not allowed to take photographs, but we all did so surreptitiously. Most evenings, after dinner, we would congregate around a small bar-counter, where we drank, joked, told stories and bought Olga drinks in the hope of making her friendlier and convert her to our western views.

The conference venue was in a scientific town, Akadem Gorodok, about twenty kilometres away, to which we were transported daily by bus. Set in the woods, it had a large conference room, many research laboratories, and a small supermarket. The Soviet delegates were housed in an on-site hotel, and we assumed the local scientists lived nearby.

We ate numerous snacks during coffee breaks and were provided with adequate lunches. Our food was obviously not from the supermarket because, as I observed during a lunchtime visit, there were very few products for sale. Most notably missing were vegetables and fruit, except for displays of black-spotted green tomatoes, miserable looking potatoes, limp carrots, and sagging cabbages. One day, just outside the supermarket, a small van appeared that suddenly had people lining up behind it. The back of

the van opened, and crates of fresh grapes were rapidly snapped up by the locals. I was about to photograph this strange event but was prevented by passers-by who raised their arms in protest.

On another day, I met a Russian geologist (L. V. Razin), who insisted I come for a private dinner, together with the late Eugen Stumpf, an Austrian mineralogist, whom I first met in 1970, when he was teaching at the University of Manchester. Razin was a large, forceful man who would not be refused. Eugen and I agreed to go. Instead of taking the bus back to our hotel, we went up to Razin's hotel room, where a fourth man acted as interpreter.

The very small room had two bunk-type beds separated by a long, low table with chairs at either end. Eugen and I sat on the beds facing each other. The table was laden with culinary delights like a meal from *The Arabian Nights*. Even small shelves in a corner were decked with beautiful grapes and other fruit, obviously not obtained locally but via VIP channels. On the table were two large bottles of vodka, two of rough brandy, and two of awful white wine. Our host made a point of showing us how to drink by first lining one's stomach with black bread covered by half-centimetre-thick butter, a feathery dill-like herb, unpeeled cucumbers, and tablespoons of caviar. Eugen did not like caviar, so Razin held a spoonful to his mouth till he nearly gagged. Razin made numerous vodka toasts that we had to drink down.

The tension was palpable: with toast, translation, drink following one after the other. I became anxious,

wondering how we could escape, while my mind conjured all sorts of possible nefarious endings. Noticing that Razin did not entirely empty his vodka glass, I pointed this out to the interpreter. A vigorous argument ensued between them, allowing me to pour my drinks into a handy potted plant.

When completely satiated, we staggered down to the lobby with Razin and boarded a large, black limousine with tinted windows. Razin insisted on accompanying us to make sure we returned safely. The waiting driver took us back to the Hotel Ob. Clearly, Razin had to have special connections to arrange so many conveniences and luxuries. True to his word, he even accompanied each of us to his hotel room, where he gave a friendly goodbye bear hug—and was never seen again.

Extract from *When Yesterday Was Today*

© 2019 by the authors

No part of this book may be used or reproduced without the prior written permission of the authors.

Cover design - Diana McCarthy & Andrew Hodgson

Cover artwork - "Autumn Stroll" by Bill McLaughlin

Illustrations - Bill McLaughlin

Layout by Andrew Hodgson & Diana McCarthy

Edited by David Sims & Gail MacDonald

Printed and bound in Canada by Merriam Print, Ottawa.

Library and Archives Canada Cataloguing in Publication.

When Yesterday Was Today: Memoirs from Abbotsford

ISBN- 978-1-9991090-0-4



For more info: minsas@gssa.org.za

INVITATION FOR SUBMISSIONS TO THE NEXT THEMED ISSUE OF THE GEODE

Minsa invites its members to contribute submissions for our next issue of the Geode, on the theme of "Mineral Pedagogics" (see below), to be published in March 2021.

Submissions can be sent to minsas@gssa.org.za and should reach us by 28th February 2021.

Submissions dealing with the teaching of mineralogy, petrology and geochemistry are solicited. These may deal with problems encountered, or lessons learned, during the online teaching of geology under lockdown, but do not have to be restricted to this. Interesting ideas with regard to the teaching of geology, mnemonics, simplified learning, and other pedagogical underpinnings or learning paradigms (philosophy of science with regard to geology and the history of mineralogy, petrology, geochemistry, etc.).

Got a service you want us to know about?

2020 Geode Advertising Rates

1/8 page = R120

1/4 page = R290

1/2 page = R575

Full page = R1150



MINSAs online symposium

On the 20th and 21st of October, MINSAs hosted its first ever online symposium. The topics covered during the two half-day sessions were based on the most recent themed Geodes: “Novel, interesting and under-utilised techniques” and “Samples, sampling and sample preparation”. MINSAs chairperson Igor Tonžetić, for the 2020-2021 term, welcomed everyone before Sara Turnbull introduced the speakers in the first session: Sabine Verryn, Sarah Glynn, Bertus Smith and Phil Harris. Sarah Glynn took over as moderator for day two, welcoming our session two speakers: Igor Tonžetić, Maggi Loubser, David Long, Carl Bergmann and Andrew Menzies. After each session there was time for open discussions, which while not as organic as at an in-person event, were still lively and interesting. MINSAs would like to thank again the various sponsors as well as Sabine Verryn who initially proposed for MINSAs to host the symposium. Over the course of

the two mornings there were approximately 120 participants (at least a third of which were students), who logged in. MINSAs decided to waive the registration fee for students in order to encourage participation, but the high number of student participants was largely due to Bridge the Gap Geosciences Guidance Program (BTG) who helped advertise the symposium on their social media platforms. BTG also assisted MINSAs by canvassing for students who required some financial assistance in order to attend the symposium. Sabine Verryn, on behalf of XRD Analytical and Consulting, was then in a position to very kindly sponsor eight students with a small data bundle each. MINSAs is thrilled by the positive feedback we received from those students on their experiences taking part in the symposium and would like to share their testimonials with you, our readers.



Ammbonaho Mudau:
Geology Honours
University of the Witwatersrand



The MINSAs online course helped me to expand my knowledge. Many concepts covered were totally new to me. Learning about the application of micro-xray analytical technique to mining was the most important highlight for me because I am more interested in mining geology.

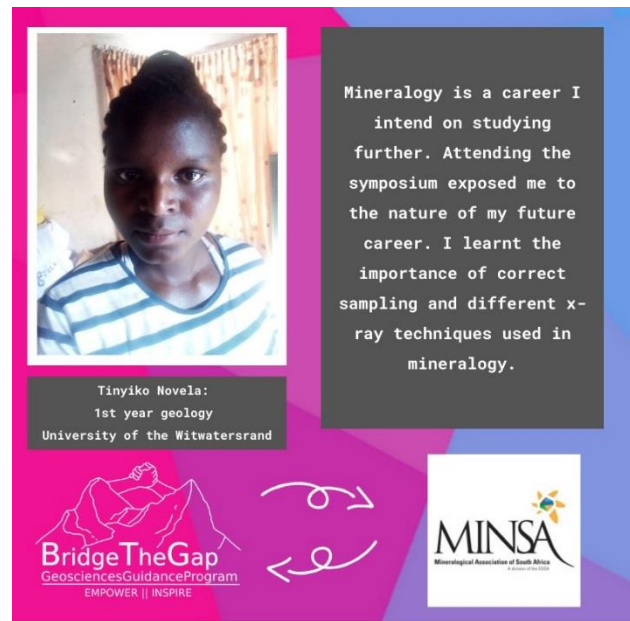



Tinyiko Novela:
1st year geology
University of the Witwatersrand

Mineralogy is a career I intend on studying further. Attending the symposium exposed me to the nature of my future career. I learnt the importance of correct sampling and different x-ray techniques used in mineralogy.

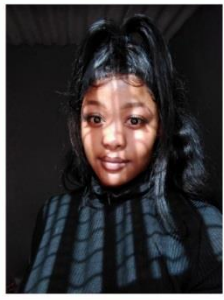

Gomolemo Nkge:
2nd year geology
University of Johannesburg

The MINSA course helped with broadening my perspective regarding the different fields in geology. I was confused about what research path to follow but I have learnt a few ideas regarding my academic and professional future. I am grateful for the opportunity and I hope the same opportunity is presented to others in the future.



Refentse Mogodie:
3rd year geology
University of the Witwatersrand

The MINSA symposium increased my interest in mineralogy. I have also learnt the necessity of professional and academic networking.



Mthulisi Mpofu: MSc geology
University of Fort Hare

Attending the MINSA course was a wonderful platform for me to gain an in-depth understanding of sampling and sample preparation. The presenters clearly explained the problems associated with mistakes in sample preparation that will in turn affect the analytical results. This course has been a preparatory phase for me as I continue with my research to produce better results and to conduct better analysis.



Zwelibanzi Mira:
2nd year geology
University of Johannesburg

The MINSA symposium broadened my knowledge of the various applications in mineralogy. I thank all the speakers and organisers who made the symposium a success. I am very grateful for the opportunity and I hope more of these events will be made available.

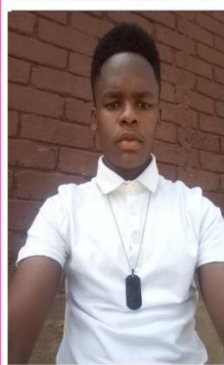

Xolani Mbhele :
2nd year geology
University of Johannesburg

The Minsa symposium was a real eye opener in the world of sampling and all the varying technology used in sampling. I gained a lot of knowledge about how the minerals are being sampled and got to understand deeper on the machines used to do such. It really was an honor to be part of such a beautiful and insightful program. I hope there will be more like it.



Geological Society of South Africa

14 October -

MINSA Online Symposium: 20-21 October 2020

To register for the Symposium, please send an email to minsa@gssa.org.za.

MINSA ONLINE SYMPOSIUM
Presented by the MinSA Committee

programme aims to provide an overview of novel, interesting, & under-utilised techniques in process mineralogy and the importance of sampling and sample preparation

PROGRAMME

Date	Topic	Speaker
20 October 2020	Travel, attendance, & under-utilised techniques in process mineralogy	
9:15 to 9:30	Login, Welcome and Introduction	COGSA
9:30 to 10:00	X-ray Powder Diffraction and Rietveld Analysis	Stefanie Venter
10:00 to 10:30	Secondary Ion Mass Spectrometry (SIMS): an under-utilised tool for cutting-edge isotopic and trace element work on a micro-scale	Sarah Claydon
10:30 to 11:00	The value of micro-focus X-ray computed tomography in mineralogy – breaking the two-dimensional log	Bertha Smith
11:00 to 11:30	Geochemical Imaging	Phil Harris
11:30 to 12:00	Open Discussion around Travel, Interesting, & under-utilised techniques in process mineralogy	
21 October 2020	Statistics, Sampling & Sample Preparation	
9:30 to 10:00	Sample preparation - Pushkin vs. Pushkin not	Igor Zaykov
10:00 to 10:30	Representative Sampling – Why and How. A look at the need and the available resources.	Maggie Louche
10:30 to 11:00	Some considerations for use of fusion discs and pressed pellets in routine XRF analysis.	David Long
11:00 to 11:30	Sampling difficulties around mineralogy	Carl Bergman
11:30 to 12:00	Open Discussion around Statistics, Sampling & Sample Preparation	

20 & 21 October
9:30 to 12:00

Contributed by Sarah Glynn
University of the Witwatersrand





Analytical and Consulting Services offered

- Phase identification of crystalline materials by X-Ray Diffraction
- Phase quantification, using the Rietveld method
- Glass (amorphous) content quantification
- XRD scanning only
- Retained austenite
- Customer specific quality control methods
- Petrographic investigation of coarse and fine aggregate for use in concrete
- Micronising in McCrone micronising mill
- Link to other analytical laboratories for XRF, and other analytical techniques
- XRD training courses

Please feel free to contact us for more information, arrangements regarding training courses and quotations.

Samples can be sent to or delivered at our mailing address.

Contact Us

Dr Sabine Verryn
75 Kafue Street
Lynnwood Glen
Pretoria, South Africa

Cell: +27 83 548 0586
e-mail: sabine.verryn@xrd.co.za
Skype address: sabine.xrd

Sample Preparation

- | | |
|-----------------------------------------------------------------------|------------------------------------------------------------|
| <input checked="" type="checkbox"/> Automated Metal Digestion | <input checked="" type="checkbox"/> Mills / Pulverisers |
| <input checked="" type="checkbox"/> Automated Systems | <input checked="" type="checkbox"/> Mixers |
| <input checked="" type="checkbox"/> Certified Reference Materials | <input checked="" type="checkbox"/> Particle Size Analysis |
| <input checked="" type="checkbox"/> Crushers | <input checked="" type="checkbox"/> Polishing Machines |
| <input checked="" type="checkbox"/> Cutting Machines | <input checked="" type="checkbox"/> Riffle Splitters |
| <input checked="" type="checkbox"/> Fusion Machines | <input checked="" type="checkbox"/> Sample Dividers |
| <input checked="" type="checkbox"/> Metallographic Sample Preparation | <input checked="" type="checkbox"/> Samplers |
| <input checked="" type="checkbox"/> Microwave Digestors | <input checked="" type="checkbox"/> Sieve Shakers |

011 482-1060 | wirsamjb@wirsam.com | www.wirsam.com



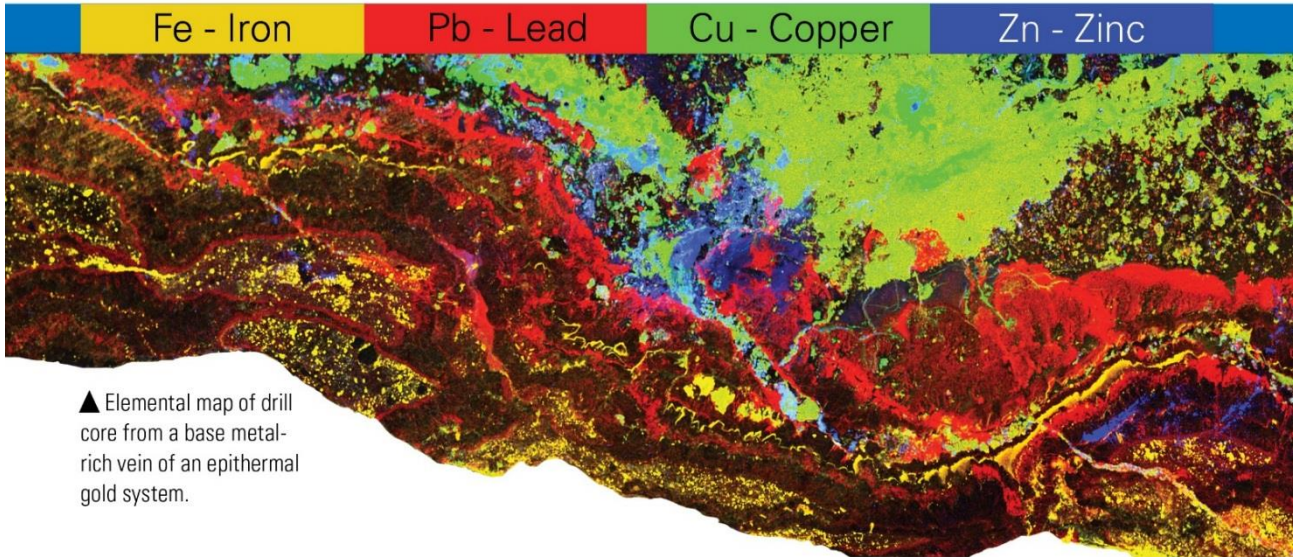

▲ Elemental map of drill core from a base metal-rich vein of an epithermal gold system.

20 mm

View rocks in a whole new way!

The M4 TORNADO desktop micro-XRF empowers geochemists and geologists to map elemental distribution on any sample - from thin sections to core slabs - without the need for polish or carbon coating.



www.bruker.com/M4TORNADO

Innovation with Integrity

Micro-XRF

Bridge the Gap is expanding!

The Bridge the Gap (BTG) team is excited to announce that our mentorship program has recently been launched within the Geology departments at the University of the Free State and the University of Johannesburg. The BTG mentorship program (operating primarily within the School of Geosciences at Wits since May 2017), is a student-led initiative designed to assist undergraduate geoscience students to better transition into the university landscape and to ignite their passion for geosciences. We aim to connect undergraduate students with either postgraduate students or industry professionals in order to present them with an academic role model, thus allowing for a positive mentor-mentee relationship to develop. The program entails regular academic assistance, practical advice and strategies for success in geosciences at both the tertiary level and within a work environment. BTG also regularly invites industry professionals to present insightful talks pertaining to relevant skills and opportunities. Previous talks include: "CV Writing Skills" with Briony Liber Coaching, "Transitioning into the Workplace" with Fabian Francis (Sasol), "Professionalism in the Geosciences" with Tania Marshall (GSSA), and "Preparing for Interviews" with Peter Roberts (Anglo American Coal) amongst many others (some of which can now be found online on our YouTube channel). All the membership perks mentioned above are offered free of charge to students taking part in the program.

Sadly, due to the circumstances surrounding the current pandemic, numerous planned talks, workshops and networking events fell through. The upshot though, is that our team has taken this opportunity to focus their energy on expanding the program into other universities and institutions. The program has recently been initiated at both the University of the Free State and the University of Johannesburg; and we are also corresponding with representatives from other universities interested in running the BTG program within their geology departments. In addition to this, we are also collaborating with the Mineralogical Association of South Africa (MINSAs) to encourage more industry professionals to join the program and spread the value of mentorship. We have also partnered with

Women in Mining South Africa (WiMSA) who were generous sponsors of data, that allowed three students to attend the recent "Foundations of a Geological Career – GeoSkills" Webinar hosted by the Geological Society of South Africa.

Lockdown has also given us the opportunity to focus on our social media presence, as being active across various platforms gives us the chance to connect with students and professionals throughout the country; and has helped us recently to increase the number of industry professional sign ups as well as spark interest from other universities. We regularly use social media as a way to engage with our audience. Some examples include: canvassing which geology-related and practical advice conversation topics students are most interested in, giving young professionals the opportunity to share their recent publications on #ResearchTuesdays, and their experience in the workplace via #ILoveGeology every Wednesday.

As we expand into other universities, our aim is to adjust our mentorship model to suit the needs of each department. This brings an exciting challenge to the BTG teams at the various departments, where we hope that the customised model approach will inspire more students to pursue postgraduate research within their institutions, knowing they have an additional support structure in place. BTG believes that mentorship is vital for student development and greatly enhances their chances for success because of the knowledge and skills that can be transferred from mentor to mentee. Our platform gives students the opportunity to develop into self-confident and independent individuals: by allowing them to take responsibility for their personal development beyond their university experience and into their working life.

The BTG team is grateful that despite the challenges posed by COVID-19, we continue to empower students through mentorship and inspire future leaders. As the program continues to expand, we would like to acknowledge the unrelenting support of our overseers from the various university departments. BTG looks forward to future collaborations and launches, and we hope to continue to empower and inspire others!



If you are interested in getting involved, please complete the Google form by clicking on the following link: <https://forms.gle/3dhNoeqmWckBvNNBA>, or for

more information, please email bridgethegap.wits@gmail.com or reach out via WhatsApp: +27 64 836 4185.

Meet the Bridge the Gap team!

University of the Witwatersrand committee



Bavisha Koovarjee
Chairperson



Mandy-Jane Sebola
Deputy Chairperson



Priyanka Davechand
Secretary



Sandiso Mnguni
Deputy Secretary



Thiashen Nadan
Treasurer



Moteng Moseri
Deputy Treasurer



Yvonne Punadi
Public Relations Officer



Selemeng Tsoenyane
Deputy Public Relations Officer

University of the Free State committee



Motlatji Molabe
Chairperson



Cheryl Matoyi
Deputy Chairperson



Sikelelwa Gqalaqa
Secretary



Mulisa Mukwevho
Public Relations Officer

University of Johannesburg committee



Gobona Lizzie Tau
Chairperson



Sinikiwe Ncube
Deputy Chairperson



Brian Mapingire
Secretary & Public Relations Officer

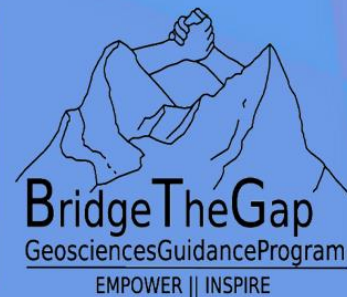

Bruce's Beauties: Argentine Rhodochrosite

Most mineral curators, collectors and dealers are familiar with the Kalahari manganese field rhodochrosite crystals. Perhaps equally famous are the stalagmites and stalactites of rhodochrosite (MnCO_3) from the Capillitas mining district in Argentina. This mine produced tons of this material used primarily for ornamental stone and object d'art. When cut and polished, as can be seen from these photos, the sequential concentric pattern of precipitation of the manganese carbonate is clearly visible as the formation crystallized.

Some formations are clustered together, as seen in this 5.6 cm slice, or they can be found as individual formations as in the photo below.





At left, a near-perfect 2 cm spherical polished section of a stalagmite / stalactite of Capillitas rhodochrosite. In this case, other minerals are present, including siderite.

Bruce Cairncross specimen and © photo.

Below, a photo taken in 1991 at the Tucson Gem & Mineral Show® of a display of Argentinian rhodochrosite. The large, back-right specimen is approximately 50 cm. Some manufactured items can be seen, including a rectangular ornamental box and large bowl. Some natural, unpolished specimens are on the left.

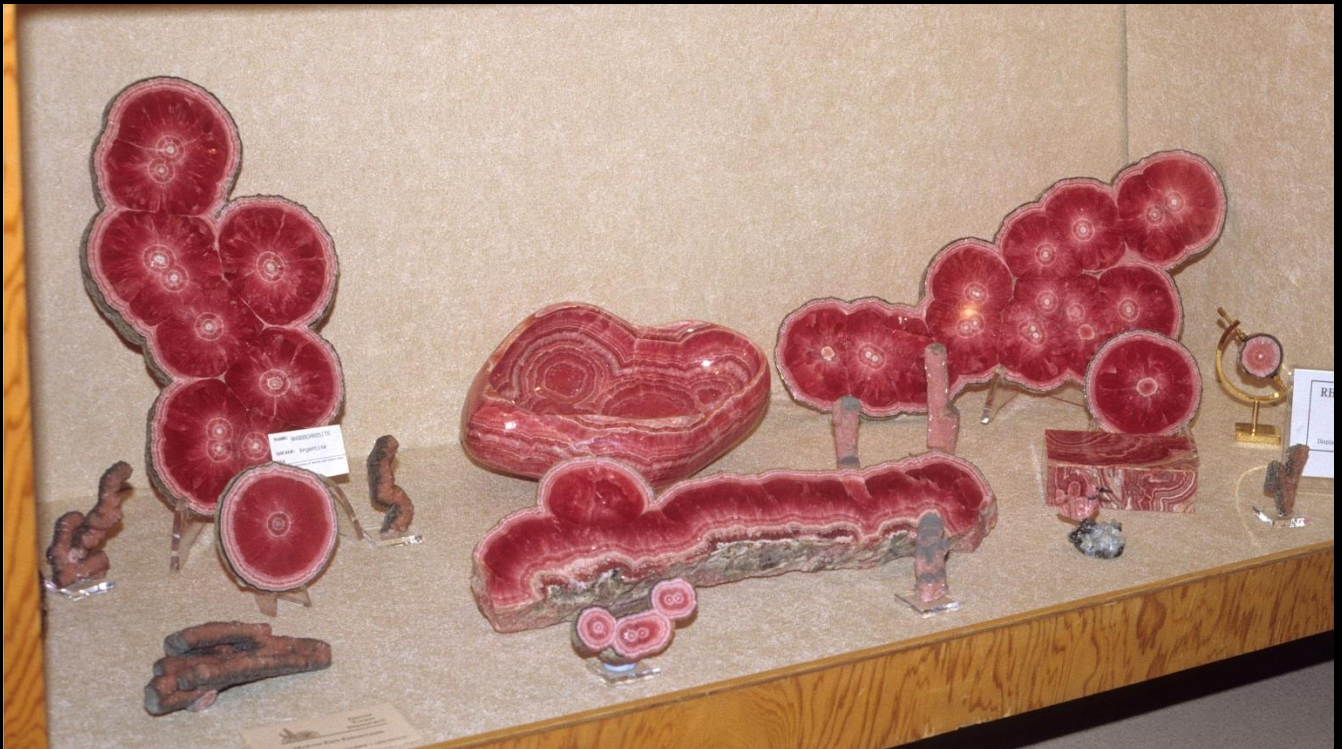

Minsa Crossword for September 2020

This puzzle's theme is South African-themed minerals; discovered here, named for South Africans, or prominently mined here.

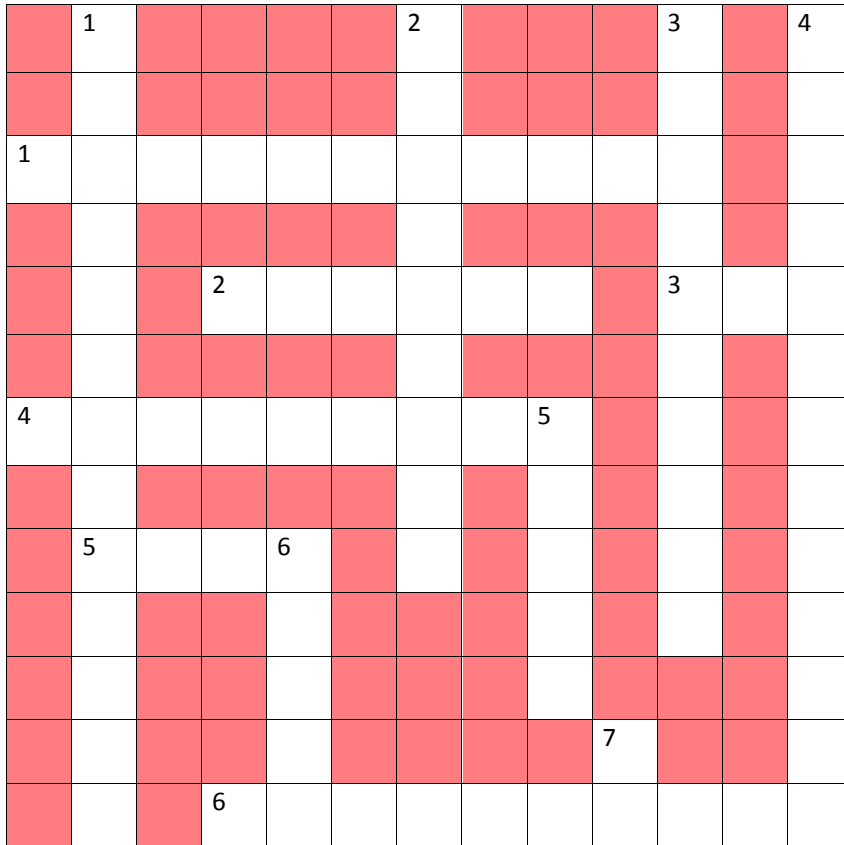

DOWN:

1. A Ni-Mg phyllosilicate mineral, $(\text{Ni},\text{Mg})_3\text{Si}_4\text{O}_{10}(\text{OH})_2$, discovered in talc schists associated with the Barberton greenstone belt, named in the 1960s by Sybrand de Waal in honour of Prof. Johannes Willemse of the University of Pretoria (as was Prof. de Waal, only much more recently).
2. The family name of the farmer on whose farm, near Colesburg, in the Northern Cape, alluvial diamonds linked to kimberlites were first discovered in South Africa, by their son, Erasmus. Alluvial diamonds had been mined along the Vaal River over the preceding 60 years, but this 1867 discovery led indirectly to the identification of Kimberley's diamondiferous blue ground a year later.
3. The generic term for any mineral commodity which can be extracted from the ground and sold for economic gain.
4. $\text{NiFe}_2^{3+}\text{O}_4$, found in serpentinites from the Barberton area, and named (in 1921) for in honour of Major Tudor Gruffydd Trevor, mining inspector for the Pretoria District, Transvaal, South Africa. And no, it isn't "majorite" (which is in fact a shock metamorphic olivine)!
5. The acronym for the flagship journal of the Geological Society of South Africa.
6. The site of the capital of the 12th Century kingdom (of the same name), now part of the Limpopo Province, in which the earliest evidence of worked gold in South Africa was found.

ACROSS:

1. A phyllosilicate, $\text{SrCa}_3\text{Na}(\text{Si}_4\text{O}_{10})_2\text{OH},\text{H}_2\text{O}^*7$, found in manganese ore dumps of the Wessels Mine, Kalahari Manganese Field, South Africa, and named in 2016 in honour of Prof. Bruce Cairncross of the University of Johannesburg for his career contributions to mineralogy.
2. NiSb_2O_6 (nickel antimony oxide), found in Ni ores from the Barberton area, and named in honour of the (now) late Prof. Marian Tredoux in recognition of her career work on Ni and precious metal ore minerals at Wits University, UCT, and finally at the University of the Free State.
3. A phosphorus ore rock composed primarily of magnetite, apatite and olivine, associated with carbonatites, and named for its discovery site at the Phalaborwa mine, Mpumalanga, operated by Foskor (Pty) Ltd of South Africa. The spelling used here links to the company spelling, rather than that of the ore element, which is otherwise valid.
4. $(\text{Ni},\text{Mg})_2\text{SiO}_4$, a nickeliferous forsteritic olivine, found in ultramafic rocks in Barberton, speculatively derived from meteoritic sources (but don't bet the farm on it). Named (by Sybrand de Waal) in honour of William Liebenberg, Deputy Director-General of the National Institute of Mineralogy (now MINTEK).
5. The Sotho name for Johannesburg, meaning "place of gold".
6. The North Sotho word for the commodity most profitably mined in the Johannesburg area over the past century and a half. The South Sotho spelling begins with 'kh', according to my sources (and will not fit, here).
7. The chemical symbol for the South African-mined precious metal currently trading at just under \$1900 U.S., and which "all that glitters" is not, necessarily.

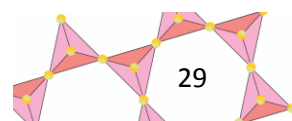

Minsa Crossword Solution for June 2020

1 _V								2 _S			
1 _E	N	D	E	3 _L	L	I	T	E			
R				E				R			
M			2 _F	U	B	A	R	I	T	E	
I				C				C			
C		3 _K	A	O	L	I	N	I	T	E	
U				X				T			4 _N
4 _L	E	A	V	E	R	I	5 _T	E			I
I				N			R				M
T		5 _G	O	E	T	H	I	T	E		I
E							T				T
		6 _C	H	R	Y	S	O	T	I	L	E
							N				

ACROSS:

1. A now-discarded (as of 2006) European name for the hydrated subspecies of kaolinite synonymous with hallyosite-10Å; $Al_2Si_2O_5(OH)_4 \cdot 2H_2O$.
2. A rock, of any type, which can be best described as “f&^%ed up beyond all recognition”; an informal descriptive term beloved of field geologists.
3. The clay mineral $Al_2Si_2O_5(OH)_4$, for which the largest economic deposits in South Africa are found (and mined) in the Makhanda area (Grahamstown).
4. The informal term for a generic rock sample that, for whatever reason, your preference is to “rock name”-there, meaning ‘not take it with you’.
5. The oxidised iron hydroxide mineral named for the (German) author of the evolutionary precursor, “*The Metamorphosis of Plants*” in 1790, and, later, *Faust*. The mineral provides the basis for the colouring pigment known as “brown ochre”.
6. The serpentine mineral forming as a high temperature alteration of olivine, which is particularly effective as a fibrous insulator, and as a carcinogen-inducer, formerly (‘til 2012!) most prominently mined near the town of Asbestos, Québec (Canada).

DOWN:

1. The phyllosilicate formed from the hydrothermal alteration of biotite or phlogopite, and characterised by (and named for) the distinctive wormy exfoliation texture when heated.
2. The mineral name for the fine grained aggregate of white micas and clays associated with hydrothermal alteration of feldspars, commonly found as phyllites and schists, and named for its silky textural appearance.
3. A brown granular hydrothermal (or weathering) alteration product of ilmenite, perovsite or titanite, mostly consisting of microcrystalline rutile.
4. A species of nickeliferous serpentine whose name derives from the National Institute of Metallurgy of South Africa, and which was found in the Barberton area, South Africa, associated with the Scotia talc mine.
5. The name of the moon of Neptune which consists largely of solid (frozen) nitrogen. OK, not exactly an alteration mineral, but only a small logical leap.

Note: The recommended deadline for submissions for the next issue of the Geode is February 28, 2021.

